

# MERCHANT CATALOGUE

# 2024

# WALTHER STRONG®

PROFESSIONALS USE  
WALTHER STRONG

TAPES & ADHESIVES

All prices plus VAT

Trustpilot ★★★★★  
We are rated 4.8 out of 5

beko® 

**MATI**

[sales@waltherstrongandco.com](mailto:sales@waltherstrongandco.com)

[www.waltherstrong.com](http://www.waltherstrong.com)

01780 437 222



# Mission Statement

*'Walther Strong has one single objective which is to provide solutions to your common construction problems...'* - Fred Dunn, MD

## MISSION

**Our mission is to provide a range of tapes and adhesives of the highest quality to builders merchants and construction companies. We aim to improve workflow, longevity and overall quality of the project.**

**We do this by combining the best raw materials and the finest products married in unique formulas, to provide innovative solutions to reoccurring or standardised problems.**

## VISION

**Our vision is to increase the standard of build quality at an uncompromising affordable cost.**

**Longevity and innovation is at the forefront of our vision to ultimately raise the bar of our sector.**





# PROJECT ACQUISITION

## Case Studies from 2023

During 2023 Walther Strong was commissioned by a range of clients to provide materials across the globe to assist with their construction builds.

Our company's tapes and adhesives are crafted with innovation at their core, redefining the standards of durability, versatility, and reliability. Infused with cutting-edge technology, our tapes have unparalleled adhesive strength, ensuring steadfast bonds across diverse surfaces and environments.

From heavy-duty industrial applications to delicate crafting needs, our adhesive solutions cater to a spectrum of requirements, offering precision, resilience, and ease of use. Our products are engineered to excel in challenging conditions, delivering superior performance that stands the test of time. With a commitment to quality and a dedication to meeting the evolving demands of our customers, our tapes and adhesives redefine adhesive solutions, setting a benchmark for excellence in the industry.

Ranging from bespoke innovative solutions to more legacy associated products, Walther Strong has now supplied over 10 countries.





## JEDDAH

A well known Jeddah project sourced Walther Strong HD Marine Acoustic tape for its intense properties to irradiate sound disruption within its marinas.



## SWITZERLAND

A Swiss Chalet sourced 5000 linear meters of Walther Strong Decktape Pro to enhance the life of the timber subframe.



## CANADA

Canadian Hotel 'Paradox' sourced Walther Strong Liquid Tape for its unique properties to be able to protect surfaces from accidental damage during refurbishment.



SCAN ME





# TABLE OF CONTENTS

"The main problem we solve is reducing wasted time.

It's the one resource we cannot reproduce and we very much respect that"

- Fred Dunn MD

06 - 09	PAINTING AND DECORATING	H2O LIQUID MASK	P07
		INTERIOR LIQUID TAPE	P08
		MASKING TAPE	P09

10 - 16	REINFORCEMENT MESH	SCRIM TAPE	P11
		RENDER MESH 1M ROLLS	P12
		RENDER MESH SIZES	P13
		DRYLINING SCRIM	P14
		ULTRA FINE MATI MESH	P15
		EVERYDAY WHITE SCRIM	P16

17 - 21	INTERIOR TAPES	CLEANROOM TAPE	P18
		ULTIMATE DUCT TAPES	P19
		UTILITY DUCT TAPES	P20
		NO RES TAPE	P21

22 - 25	DECKING	DECKTAPE	P23
		DECKTAPE INFO	P24
		DECKTAPE PRO	P25

26 - 30	LANDSCAPING	CLAD TAPE	P27
		POST TAPE	P28
		POST TAPE INFO	P29
		SLEEPER TAPE	P30

31 - 33	ROOFING	BUTYL TAPE	P32
		ALUMINIUM FOIL TAPE	P33

34 - 37	RILICONE FAMILY	SMOOTHING SPRAY	P35
		SILICONE	P36
		JOINT SPATULAS	P37

38 - 46	ENVELOPE TAPES	FIRE RATED VEIL MESH	P39
		ISO ACOUSTIC TAPE	P40
		HD ACOUSTIC TAPE	P41
		EXPANDING FOAM TAPE	P42
		GALAGO TAPE	P43
		MATI MOUNT	P44
		HOUSEWRAP	P45
		FLASHING/ AIRTIGHT TAPE	P46



# PAINTING AND DECORATING



Your time is important to us!

What does Painting and Decorating have to do with tape??? Well... we will tell you. During our time in the industry, the constant feedback we received from tradesmen, was that protecting surfaces was a HUGE time consumer, and took up a large amount of their working week when on jobs. Not to mention tedious! Considering the issue, Walther Strong developed two products for the painting and decorating community to assist with this problem.

## H20

H20 liquid prime and mask is both a primer and a painting separator. Proven by contractors to be more cost-effective than masking up and saving large amounts of time through application. Plus its so satisfying to use.

## LIQUID TAPE

With naturally sourced materials and being completely biodegradable, this product can be classified as a natural based latex. Despite its yellow colouring and its polymer look this product won't just mimic the properties of masking tape but also solidify over 'hard to mask' areas making it the perfect addition to protecting surfaces in high activity areas. Bathrooms and shower basins get covered with the thick material and are left to dry. Once dried a protective barrier is formed leaving the surrounding areas to be modified without compromising the treated area. Once perfected it is simply peeled away.

[sales@waltherstrongandco.com](mailto:sales@waltherstrongandco.com)

01780 437 222



# H2O LIQUID MASK

7

## FEATURES

- 2 IN 1 PRIMER AND MASK
- CAN BE APPLIED WITH A SPRAYER [BOTH HVL AND AIRLESS] / ROLLER OR BRUSH
- PROVEN BY CONTRACTORS TO BE MORE COST EFFECTIVE THAN TRADITIONAL MASKING UP
- ACHIEVE PERFECT PAINT SEPARATION AND CLEAN EDGES WITH MINIMAL EFFORT.
- SIMPLE 4 STEP PROCESS.

PRODUCT CODE	PRODUCT DESCRIPTION	BOX QTY
H20-PRIME-1LTR	1LTR TIN	6
H20-PRIME-5LTR	5LTR BUCKET	1
H20-PRIME-25LTR	25LTR BUCKET	1



**SCAN TO WATCH**  
How to apply H2O Liquid Prime & Mask



SCAN ME



## MASKING TAPE

We make sure that the pros who insist on cutting in and masking up with tape are supplied with one of the best on the market - no tack lost once opened - constant reliability (P9).





## FEATURES

- PERFECT FOR DIFFICULT SHAPES AND/OR ROUGH SURFACES
- PROTECTIVE AND DURABLE YET FLEXIBLE MEMBRANE
- SIMPLY PAINT ON, DRY AND PEEL OFF ONCE THE JOB IS DONE
- EASY MASKING OF DIFFICULT SHAPES WITH UNEVEN EDGES
- CLEAN REMOVAL WITH NO DAMAGE TO THE INITIAL SURFACE
- REGULARLY USED AS A PROTECTION TO THE SURROUNDING AREA WHEN SANDBLASTING BEAMS



### DID YOU KNOW?

This product is a natural based latex product! Its biodegradable and non plastic - perfect for your eco-conscious friends and family when considering the environment.

PRODUCT CODE	PRODUCT DESCRIPTION	BOX QTY
WSLT-PRO250	250ML TIN	12
WSLT-PRO1	1LTR TIN	5
WSLT-PRO2.5	2.5LTR TIN	4
WSLT-PRO5	5LTR TIN	1



## FEATURES

- PREMIUM QUALITY - MADE WITH ONLY THE BEST MATERIAL
- HIGH QUALITY COLOUR SEPARATORS
- 14 DAY RESIDUE-FREE AND UV RESISTANCE
- HIGH TENSILE STRENGTH TO PREVENT UNNECESSARY TEARING
- AVAILABLE IN 3 POPULAR WIDTHS 25MM [1 INCH] / 38MM [1.5 INCH] AND 50MM [2 INCH]

PRODUCT CODE	PRODUCT DESCRIPTION	BOX QTY
GP-14PRO25X50/1	25MM X 50MTR	36
GP-14PRO38X50/1	38MM X 50MTR	24
GP-14PRO50X50/1	50MM X 50MTR	24

With a UV resistant, high tack hybrid adhesive, this premium masking tape has a very good tensile strength for masking, bundling, holding & packing. Removes cleanly from a variety of surfaces after up to 14 days – leaving no residue. Excellent adhesion on wood, glass, plastic, metal and more!

**25MMx50M**  
GP-14PRO25X50P

**38MMx50M**  
GP-14PRO38X50P

**50MMx50M**  
GP-14PRO50X50P

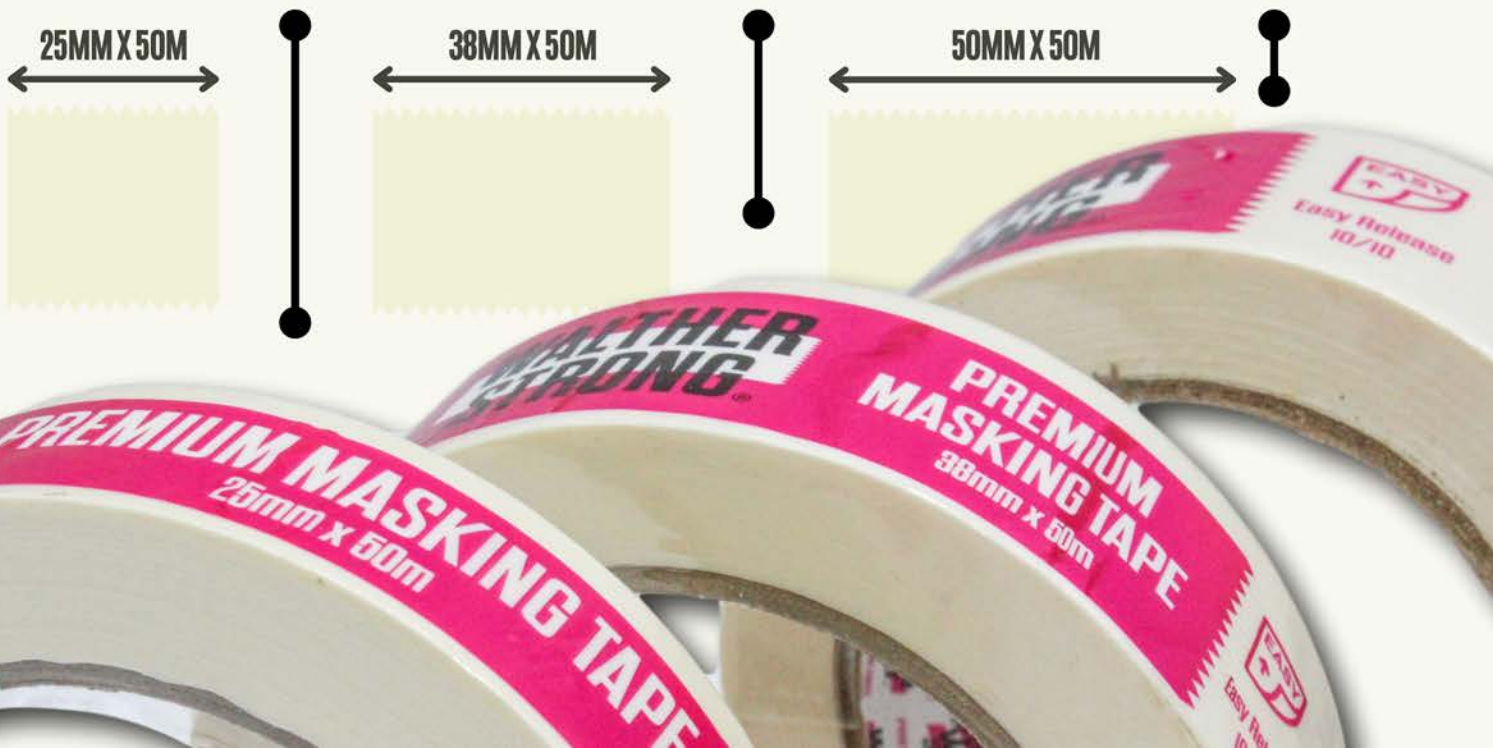





# WOVEN MESH

## What makes our Scrim Tape different?

During 2023 Walther Strong set out to change how people thought about Scrim tape - it isn't just another item... it's an essential supporting product in the process of plastering. Therefore, after reaching out to the plastering community, we received feedback to make the mesh finer, with greater adhesive and stronger mesh fibres.

Our woven mesh range doesn't just stop at Scrim. We have been busy manufacturing ALKAMAXX coated render mesh, which has one of the best alkali-resistant coatings on the market, to ensure that there is no decay associated with rendering throughout the project's lifetime.

Finally our bespoke range of White Scrim and Ultra fine woven mesh has come to the forefront of our range getting new use cases in professions such as venetian plastering and reinforcement for concrete screed floors. A bespoke use for the Ultra fine mesh is to apply to houses from the Victorian era. The ultrafine mesh will reinforce the buildings structure and reduce the amount of multi-finish/plaster due to the smaller widths of the product.



Castle Inverness  
50mm, 75mm and  
100mm all used on the  
rennovation  
*Artisan Plastering*



# ORANGE SCRIM TAPE

## FEATURES

- TESTED AND APPROVED IN BOTH HOT AND COLD ENVIRONMENTS
- INCREASED ADHESIVE TO DOUBLE THE TACK
- HEAVY DUTY SCRIM FOR THE BEST ANTI-CRACK FINISH
- ALKALI RESISTANT
- ORANGE FOR A REASON - EASY TO SEE WHEN FLOATING OFF

PRODUCT CODE	PRODUCT DESCRIPTION	BOX QTY
TP-ORNSCRIM50X90PR	50MM X 90MTR	36
TP-ORNSCRIM75X90PR	75MM X 90MTR	24
TP-ORNSCRIM100X90PR	100MM X 90MTR	18

✓  
✓  
✓  
**RELIABLE  
FINER  
STICKIER**

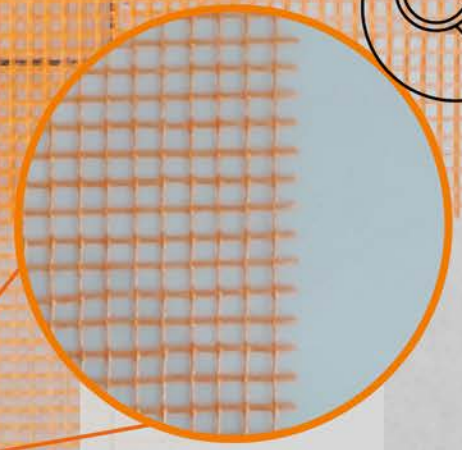

**WALTHER STRONG®**

**HEAVY DUTY SCRIM TAPE**

PROFESSIONAL PLASTERERS SCRIM FOR DRYWALL, PLASTER, WALLS & CEILINGS

EASY & QUICK TO APPLY WITH DOUBLE ADHESIVE

TP-ORNSCRIM50X90PR 50MMX90MTR

www.waltherstrong.com 01780 437222

EXTRA FINE MESH  
25% MORE ADHESION

WWW.WALTHERSTRONG.COM

### CORE CONCEPTS

- FINER MESH
- 25% MORE ADHESION
- STRONGER TENSILE STRENGTH

ALL LEADS TO FASTER  
INSTALL TIME AND A  
MORE RELIEABLE  
PRODUCT



# RENDER MESH - 1M RANGE

12

## FEATURES

- HEAVY DUTY, SUPER STRONG & FLEXIBLE
- VERSATILE - APPROVED FOR USE WITH ALL MAJOR PLASTERS AND RENDERS
- DURABLE - EXCEEDS DIN 53857
- EASY TO USE - CUT TO SIZE WITH KNIFE OR SCISSORS
- SAFE - NO SHARP EDGES
- MAINTENANCE FREE - TEAR AND WATER RESISTANT
- THE NUMBER #1 ALKALINE RESISTANT COATING IN EUROPE

PRODUCT CODE	PRODUCT DESCRIPTION	BOX QTY
HD-RFMESH/1000-4X4	WHITE 1MTR X 50MTR	3
HD-RFMESHORN/1000-4X4	ORANGE 1MTR X 50MTR	3
HD-RFMESH/1000-4X4	WHITE 1MTR X 50MTR	40
HD-RFMESHORN/1000-4X4	ORANGE 1MTR X 50MTR	40



INTRODUCING OUR LATEST INNOVATION IN RENDER MESH TECHNOLOGY, ENGINEERED TO REDEFINE DURABILITY IN THE MARKET. OUR NEW RENDER MESH RANGE, BOASTS AN UNPARALLELED ALKALI-RESISTANT COATING, SETTING A NEW STANDARD FOR LONGEVITY AND PERFORMANCE IN CONSTRUCTION MATERIALS - IT'S ALKAMAXX

SPECIALLY CRAFTED TO WITHSTAND THE HARSHTEST ALKALINE ENVIRONMENTS, THIS ADVANCED COATING ENSURES EXCEPTIONAL RESILIENCE AGAINST DETERIORATION, GUARANTEEING AN EXTENDED LIFESPAN FOR YOUR RENDERS.

OUR RENDER MESH RANGE OFFERS UNPARALLELED PROTECTION, PROVIDING PEACE OF MIND FOR BUILDERS, ARCHITECTS, AND HOMEOWNERS ALIKE.

**ALKAMAXX MESH WORKS WITH ALL ETICS SYSTEMS**





# RENDER MESH - CUT TO SIZE

13

## FEATURES

- 100MM GUIDELINES FOR EASE OF USE
- PRE CUT TO 3 DIFFERENT SIZES
- 3X SIZES IN EACH COLOUR
- WAVED MESH FOR EASY OVERLAP
- MAINTENANCE FREE - TEAR AND WATER RESISTANT
- THE NUMBER #1 ALKALINE RESISTANT COATING IN EUROPE



PRODUCT CODE	PRODUCT DESCRIPTION	BOX QTY
HD-REPMESH/200-4X4	WHITE 200MM X 50MTR	20
HD-REPMESHORN/200-4X4	ORANGE 200MM X 50MTR	20
HD-REPMESH/330-4X4	WHITE 330MM X 50MTR	12
HD-REPMESHORN/330-4X4	ORANGE 330MM X 50MTR	12
HD-REPMESH/500-4X4	WHITE 500MM X 50MTR	6
HD-REPMESHORN/500-4X4	ORANGE 500MM X 50MTR	6



TO WATCH OUR ENTIRE RENDER MESH MANUFACTURING PROCESS AND COATING APPLICATIONS SCAN THE QR CODE BELOW



DATA POINTS, CORE INFORMATION AND PRODUCT GUIDANCE CAN ALL BE FOUND ON THIS PAGE.

WHAT ARE ETICS GUIDELINES??  
SCAN HERE



NEVER HEARD OF ALKAMAXX?

ITS THE MARKET NAME FOR THE BEST ALKALI RESISTANT COATING NOW ON OUR WHOLE RENDER MESH RANGE!



# DRYLINING SCRIM TAPE

14

## FEATURES

- DESIGNED FOR DRYLINERS - 180MTR ROLLS TO MAXIMISE EFFICIENCY
- WHITE COLOUR FOR BEST VISIBILITY COVERAGE
- PERFECT WITH AN APPLICATION GUN FOR EASY SINGLE-HANDED USE
- AVAILABLE IN 50MM X 180MTR SIZE
- SUPERIOR ADHESIVE

PRODUCT CODE	PRODUCT DESCRIPTION	BOX QTY
TP-XLSCRIM50X180	50MM X 180MTR WHITE	12

To enquire about the MARSHALLTOWN gun - please call us.



The 180mm is for the plastering professional who has very large contracts on - LONGER than any other scrim tape on the market.



Perfect compatibility with the MARSHALLTOWN gun that completes corners and patching up with ease and speed.





# ULTRA FINE MATI MESH

15

## FEATURES

- TESTED AND APPROVED FOR USE WITH ALL MAJOR PLASTERS AND RENDERS
- PERFECT FOR INTERNAL USE WHERE A PREMIUM FINISH IS REQUIRED
- ULTRA THIN MESH COMPLIMENTING VENETIAN PLASTERING
- THIN, DURABLE AND GREAT TO USE WITH MICROCEMENT
- EASY TO CUT AND MODIFY FOR BESPOKE JOBS
- GREAT FOR COVERING INTERNAL CRACKS AND CREASES



AS USED BY  
BELLO VENETIAN  
PLASTERING



## HAVE YOU SEEN OUR PULL TEST?....

We have a lab on site, where we make new products and ranges. Before we can release them into the market we test them vigorously.

Scan the QR CODE to watch our full scrim test and how our meshes compare to other ranges in the industry. Long and technical, but interesting none the less.

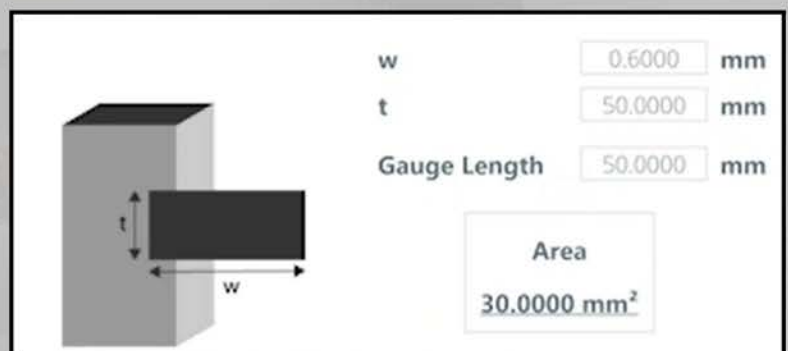

PRODUCT CODE	PRODUCT DESCRIPTION	BOX QTY
UFMESH50X1WHT	1MTR X 50MTR	3
UFMESH50X1WHT	1MTR X 50MTR	40



# WHITE SCRIM TAPE

## FEATURES

- ELIMINATES THE NEED FOR PRE-PLASTERING
- ADHESIVE TESTED IN A VARIETY OF ENVIRONMENTS
- PREVENTS CRACKING IN PLASTER
- AVAILABLE IN 3 SIZES 50MM [2"] / 75MM [3"] AND 100MM [4"]

PRODUCT CODE	PRODUCT DESCRIPTION	BOX QTY
TP-SCRIM50X90PR	50MM X 90MTR WHITE	36
TP-SCRIM75X90PR	75MM X 90MTR WHITE	24
TP-SCRIM100X90PR	100MM X 90MTR WHITE	18



## POS SINAGE AND MATERIALS



**BIRDCAGE**  
The birdcage is perfect for showcasing all three sizes (left)

**POWER PALLET**  
Best bulk POS - needs floorspace but very effective when positioned at entrances (middle top right)



**WALL HANG**  
Great for unused wall space and add ons (far right).

**TRIPOD**  
Perfect for desk counters and smaller areas (bottom middle left).

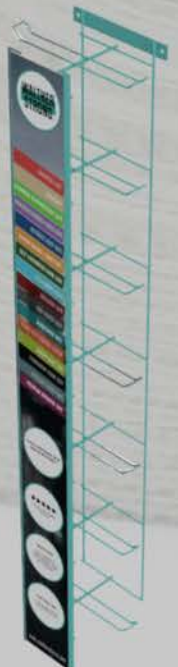



# INTERIOR TAPES



## Quality over Quantity

Our company takes immense pride in crafting the finest interior tapes available on the market today. What sets our products apart is a meticulous blend of cutting-edge technology, premium-quality materials, and a relentless commitment to excellence.

First and foremost, our interior tapes are engineered to deliver unparalleled performance. They're designed to withstand varying conditions, ensuring steadfast adhesion and durability. The adhesive we use is not only strong but also residue-free, easy and clean removal without any damage or unsightly marks left behind.

Moreover, our tapes undergo rigorous testing to meet and exceed industry standards. From superior tensile strength to exceptional flexibility, they're built to handle a wide array of applications, For painting, masking, or securing surfaces during renovation or construction.

What truly distinguishes our interior tapes, however, is our unwavering dedication to customer satisfaction. We actively listen to feedback, incorporating user insights into continuous improvements, ensuring that every roll of tape delivers consistent, reliable results.

Ultimately, our commitment to innovation, quality, and customer-centricity is what makes our interior tapes the preferred choice for the professionals and DIY enthusiasts who seek to use nothing but the best for their projects.



# CLEANROOM TAPE

## FEATURES

- DESIGNED FOR RENOVATION OR PLASTERING TO PROTECT DELICATE OR IMPORTANT SURFACES
- HIGH ADHESION LEVEL
- INSULATOR UP TO 600V
- LEAVES NO MARKS OR RESIDUE WHEN PEELED OFF
- UNIQUE AND EASY TO TEAR TO SIZE BY HAND - TEAR RIBBING
- ROHS CERTIFIED AND MEETS COSHH REGULATIONS

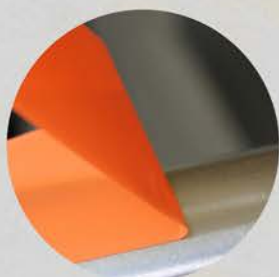

CLEANROOM WAS ONE OF OUR MOST REQUESTED PRODUCTS OF 2023.

ANOTHER SISTER PRODUCT WHICH ACHIEVES SIMILAR RESULTS IF YOU ARE IN THE MARKET IS OUR 'NO-RES' TAPE FOUND ON P21.

PRODUCT CODE	PRODUCT DESCRIPTION	BOX QTY
CR-ORN50X33/1	CLEANROOM TAPE ORANGE 50MM X 33M	24

ALWAYS TEST THE SURFACE BEFORE USE. INTERIOR USE ONLY.



## FEATURES

- QUADRUPLE LAYER REINFORCEMENT FOR HEAVY DUTY APPLICATIONS
- WEATHER-PROOF COMPATIBILITY FOR ALL REPAIRS
- EASY-CUT WITH SCISSORS OR A KNIFE
- AVAILABLE IN 3 COLOUR VARIATIONS
- TWO DIFFERENT WIDTHS - 50MM [2 INCH] AND 75MM [3 INCH]

	PRODUCT CODE	PRODUCT DESCRIPTION	BOX QTY
	TP-WHT50X50PR	50MM X 50MTR WHITE	24
	TP-BLK50X50PR	50MM X 50MTR BLACK	24
	TP-SIL50X50PR	50MM X 50MTR SILVER	24
	TP-WHT75X50PR	75MM X 50MTR WHITE	16



WALTHER STRONG ULTIMATE DUCT TAPE PROVIDES NUMEROUS TAPING SOLUTIONS INCLUDING PATCHING, BUNDLING, REINFORCING, TABBING, TAPING/SPLICING INSULATION, CAPPING PIPES, SECURING CONDUIT ENDS, MARKING, LABELLING, TEMPORARY REPAIR, HANGING POLYETHYLENE SHEETS AND PROTECTING AGAINST LIGHT SANDBLAST OVERSPRAY.

DESIGNED AND MANUFACTURED TO BE MOULD- AND WATER-RESISTANT, ULTIMATE DUCT TAPE'S STRONG FORMULATION ADHESIVE IS PERFECT FOR MORE DEMANDING APPLICATIONS.





# UTILITY DUCT TAPE

20

## FEATURES

- TRIPLE LAYERED FOR STRENGTH AND DURABILITY
- IDEAL FOR EVERY-DAY REPAIRS AND BUNDLING
- EASY-CUT WITH SCISSORS OR A KNIFE
- AVAILABLE IN BOTH BLACK AND SILVER
- TWO DIFFERENT WIDTHS - 50MM [2 INCH] AND 75MM [3 INCH]

	PRODUCT CODE	PRODUCT DESCRIPTION	BOX QTY
	UT-BLK50X50PR	BLACK 50MM X 50MTR	24
	UT-SIL50X50PR	SILVER 50MM X 50MTR	24
	UT-BLK75X50PR	BLACK 75MM X 50MTR	16
	UT-SIL75X50PR	SILVER 75MM X 50MTR	16

*\*Example colours are not exact. Only for general guidance\**



UTILITY DUCT TAPE IS THE GO-TO TAPE FOR EVERYDAY USE. TRUSTED BY CONTRACTORS, DEVELOPERS AND BUILDERS ACROSS THE UK, IT'S A QUICK SOLUTION FOR HOLDING, SEALING AND BUNDLING.





EASY TO TEAR ALONG THE REINFORCED FIBRES IN THE TAPE, YET EXTREMELY TOUGH AND VERSATILE. APPLICATION BY HAND ACTIVATES THE PRESSURE SENSITIVE ADHESIVE AND GIVES IT THE GRIP YOU NEED.

MULTI-SURFACE, WIDELY USED IN BUILDING AND AGRICULTURAL USES. IDEAL FOR HIGH-VOLUME, PRICE CONSCIOUS USERS; SUITABLE FOR GENERAL USE, BOTH INDOORS AND OUTDOORS.



## FEATURES

- AN ALTERNATIVE TO DUCT TAPE WHICH LEAVES NO RESIDUE
- UNIQUE EASY-TEAR TECHNOLOGY
- HIGH ADHESION AND COHESION LEVELS
- LEAVES NO MARKS OR RESIDUE ON INTERIOR APPLICATIONS
- PRO-TEAR TECHNOLOGY. DESIGNED TO BE REUSABLE

	PRODUCT CODE	PRODUCT DESCRIPTION	BOX QTY
	NR-ORN50X33P	NO-RES TAPE ORANGE 50MM X 33M	24
	NR-BLK50X33P	NO-RES TAPE BLACK 50MM X 33M	24
	NR-SIL50X33P	NO-RES TAPE SILVER 50MM X 33M	24
	NR-WHT50X33P	NO-RES TAPE WHITE 50MM X 33M	24

**NUMBER #1**  
PRODUCT USED FOR  
CORREX BOARDS

CARPET WOOD PAINTED SANITARY LEATHER METAL GLASS

AVAILABLE IN - 



-  NO-RESIDUE
-  ELECTRICAL INSULATOR
-  EASY TEAR
-  HIGH STRENGTH
-  REPOSITIONABLE





# DECKING



There IS nothing better...

Decktape<sup>®</sup> is the renowned global leader in joist and timber protection. It's a superior product to apply to wood than butyl or bitumen products which have been common applications for years.

When you take into consideration that decking projects cost anywhere from £3,000 up we couldn't understand why the timber subframe of the deck wasn't protected with the highest quality material. Decktape costs 3% of the overall decking project cost and will enhance your deck frame life for up to 15 years.

Our Timber Protection range is a one stop solution to Timber protection. Its a product that's, more environmentally friendly, cures into the wood, breathing with the timber, doesn't crack under weather changes, ensuring the composite materials are sat on sturdy subframes for years to come. We believe our timber tapes are a logical investment!



DID YOU KNOW...

That Millboard install over 19,500,000 liner meters of composite decking in the UK alone every year?

[sales@waltherstrongandco.com](mailto:sales@waltherstrongandco.com)

01780 437 222





## FEATURES

- UV STABLE
- COMPLETELY SELF-SEALS AROUND FIXINGS
- AVAILABLE IN 8 WIDTHS
- PERMANENT ADHESIVE BOND GUARANTEED FOR 50 YEARS
- MADE WITH RECYCLED & SUSTAINABLE MATERIALS
- ADHESIVE CURES INTO TIMBER OVER THE NEXT 7 DAYS FOR THE OPTIMUM BOND - PTO FOR INFOGRAPHIC

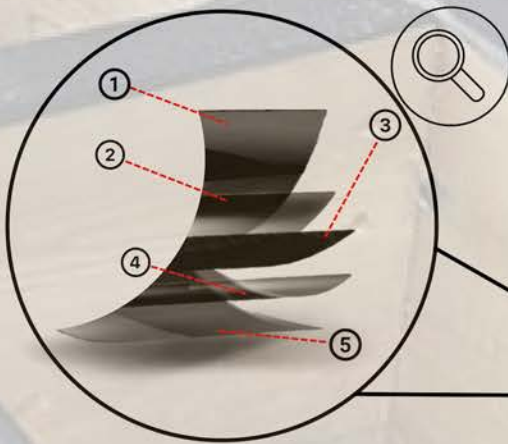

- ① UV & WATERPROOF LAYER
- ② ULTRA HIGH STRENGTH WEAVE
- ③ UV & WATERPROOF LAYER
- ④ SPECIALIST PMMA ADHESIVE
- ⑤ EASY PEEL PAPER BACKING



PRODUCT CODE	PRODUCT DESCRIPTION	BOX QTY
WS50PRO20BLK	50MM X 20MTR BLACK	30
WS65PRO20BLK	65MM X 20MTR BLACK	24
WS82PRO20BLK	82MM X 20MTR BLACK	18
WS100PRO20BLK	100MM X 20MTR BLACK	15
WS150PRO20BLK	150MM X 20MTR BLACK	10
WS200PRO20BLK	200MM X 20MTR BLACK	6
WS250PRO20BLK	250MM X 20MTR BLACK	6
WS300PRO20BLK	300MM X 20MTR BLACK	6



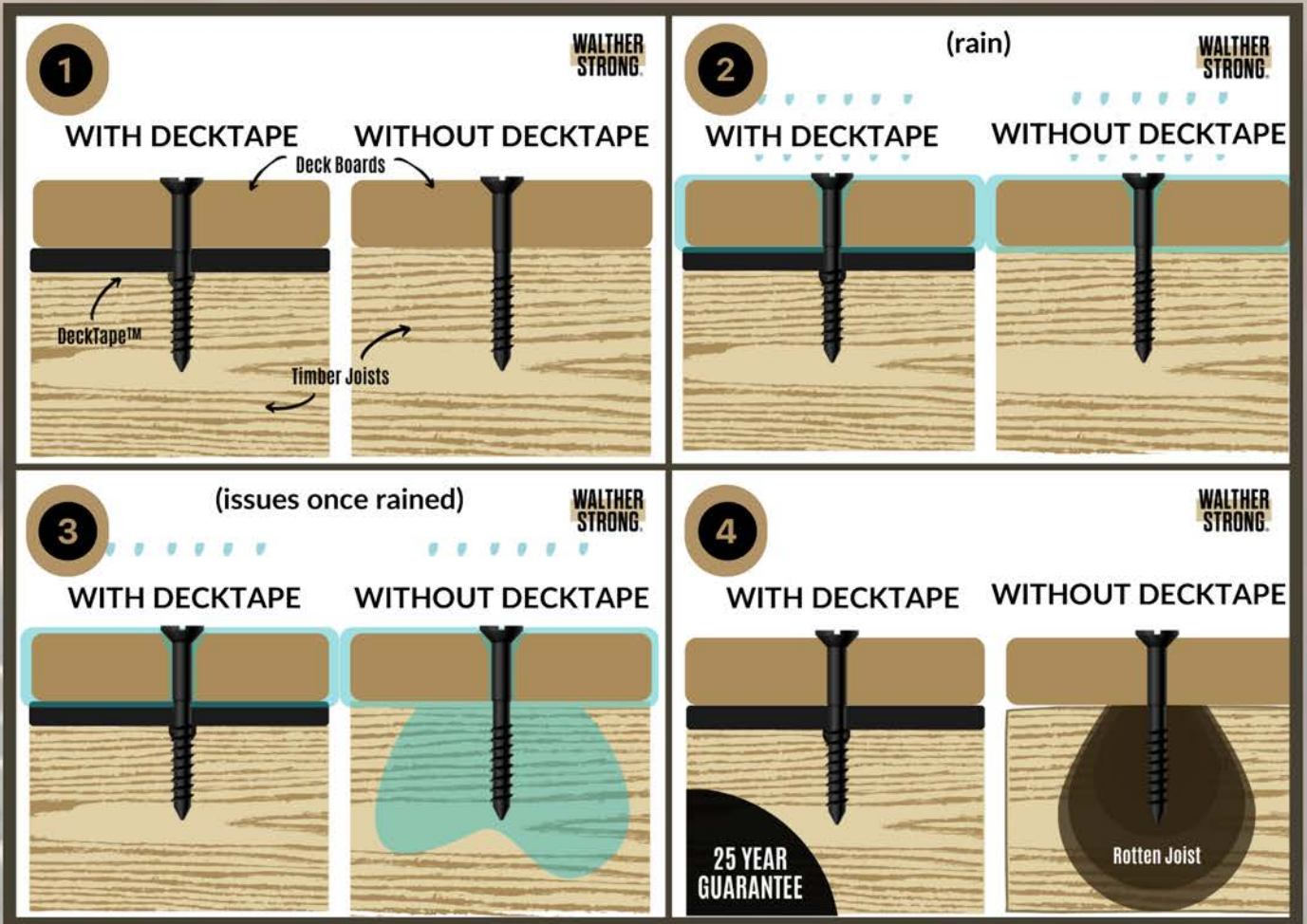

## Coloured water test :

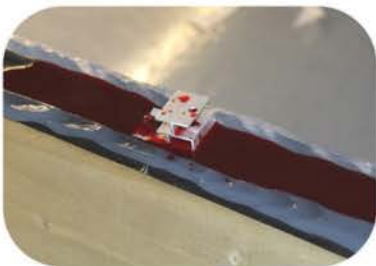
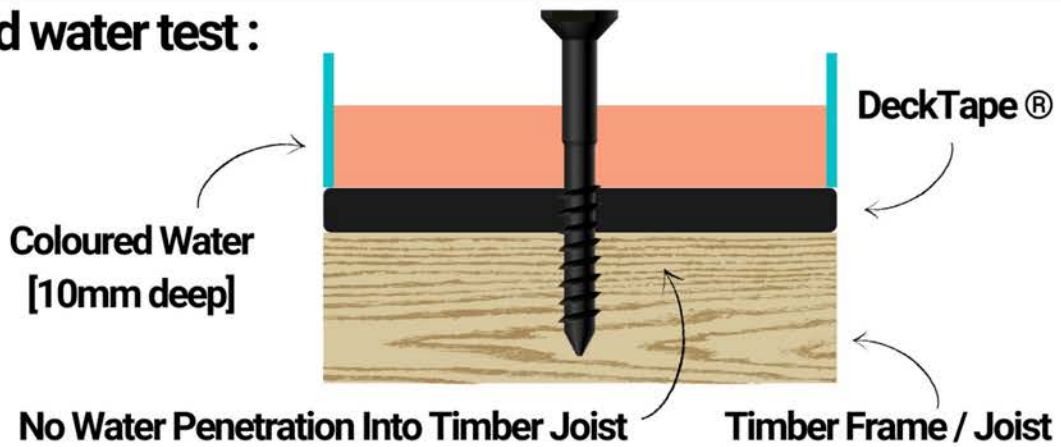

Dyed water test in action



Complete seal around screws



No Water Penetration

Completely self-sealed when fastener is driven through the DeckTape®



## FEATURES

- 2.5X BIGGER & 2.5X FASTER
- MADE WITH RECYCLED MATERIALS
- NO BACK LINER ON THE TAPE FOR QUICKER APPLICATION
- UV STABLE - WILL NOT BREAK DOWN WITH SUN
- PROTECTIVE DECK TAPE FOR THE PROFESSIONAL LANDSCAPER
- CONTACT COMPLETELY SELF SEALS AROUND FASTENERS
- PERMANENT ADHESIVE BOND GUARANTEED FOR 25 YEARS

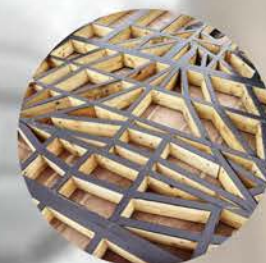

Gun availability upon request 

PRODUCT CODE	PRODUCT DESCRIPTION	BOX QTY
DTPRO50X50BLK	50MM X 50MTR BLACK	12

DeckTape PRO revolutionises timber framework protection by offering unmatched speed, eco-friendliness, and cost-effectiveness compared to any other like for like product. The innovative design enables rapid application due to having no liner on the tape, ensuring swift and efficient coverage of timber frameworks all on a 50M roll. With DeckTape, you get unbeatable efficiency, sustainability, and value for safeguarding your timber framework.







# LANDSCAPING

## Designed by the Pros

When looking at the landscaping industry we saw three sectors that were in desperate need of attention. They were:

- FENCING
- CLADDING
- SLEEPERS

For us, it's about sustainability, increasing our positive economic impact and saving the installer time where we can. Why paint a less effective timber protection onto your products that leach into your soils? Why spend hours putting multiple coats onto a product when you can spend 2 minutes taping your timber utilising your workforce? Why wait for your timber protection to dry?

We promise once you use our landscaping range, you'll never go back.

### DID YOU KNOW...

That the average lifespan of treated timber fencing is only 5 years without protection?



## FEATURES

- COMPLETELY UV STABLE
- APPROVED REPLACEMENT TO EPDM
- ADHESIVE BOND GUARANTEE FOR 25 YEARS
- SELF-SEALS AROUND ANY FASTENERS
- MADE WITH THE BEST NON-BUTYL PRODUCT ON THE MARKET
- MADE WITH RECYCLED & SUSTAINABLE MATERIALS

PRODUCT CODE	PRODUCT DESCRIPTION	BOX QTY
CT50PRO20BLK	50MM X 20MTR BLACK	30
CT65PRO20BLK	65MM X 20MTR BLACK	18

It's not all about what it looks like on the outside, if you have a stunning cladding board its worth investing on the substructure. Walther Strong Clad Tape® is a non-butyl self-sealing tape manufactured from a strong polymer acrylic adhesive, which gives the timber battens a completely waterproof and weatherproof seal. With a 25-year guarantee, Clad Tape® ensures your battens last as long as your composite cladding boards. Non-Butyl tapes are particularly suitable for this application as they are completely UV stable and keep their integrity for longer. This means that they have many advantages over both butyl and asphalt tapes. In addition to this, it is stable from -40C to +93C with no cracking, peeling or strength loss.



DOWNLOADABLE  
ACCOYA FLYER  
CLADDING AND  
DECKING





## FEATURES

- QUICK AND EASY TO APPLY - NO HASSLE
- NO APPLICATION TOOLS OR KITS NEEDED
- 100MM/150MM AND 200MM WIDTHS - DESIGNED TO PROTECT THE 'ROTTING ZONE' JUST ABOVE AND JUST BELOW GROUND LEVEL
- GUARANTEED FOR 25 YEARS
- MADE WITH RECYCLED & SUSTAINABLE MATERIALS
- COMPLETELY UV STABLE

PRODUCT CODE	PRODUCT DESCRIPTION	BOX QTY
PT100PRO20BLK	100MM X 20MTR BLACK	15
PT150PRO20BLK	150MM X 20MTR BLACK	10
PT200PRO20BLK	200MM X 20MTR BLACK	6

This product can be resold by the roll or by strips!

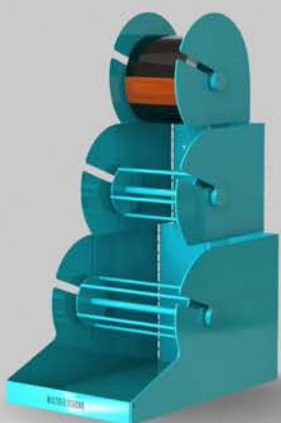

THE WALTHER STRONG DISPENSER was designed specifically for this product so that the builders merchant or installer could strip the tape to any lengths or sizes for bespoke projects or quantities. This means no matter the scale of the project all posts can be protected with minimal waste .



Its important to note that every Post needs protecting and as our rolls are designed to cover whole projects its important to have a guideline as to what is achievable with our 20M rolls.

POST SIZE	OVERLAP ON POSTS	POSTS COVERED PER ROLL
8X8 INCHES (SQUARE)	A MAXIMUM OF 60MM OVERLAP	23 POSTS
7X7 INCHES (SQUARE)	A MAXIMUM OF 60MM OVERLAP	26 POSTS
6X6 INCHES (SQUARE)	A MAXIMUM OF 60MM OVERLAP	30 POSTS
5X5 INCHES (SQUARE)	A MAXIMUM OF 50MM OVERLAP	36 POSTS
4X4 INCHES (SQUARE)	A MAXIMUM OF 40MM OVERLAP	45 POSTS
3X3 INCHES (SQUARE)	A MAXIMUM OF 40MM OVERLAP	55 POSTS
6 INCHES (ROUND)	A MAXIMUM OF 40MM OVERLAP	40 POSTS
4 INCHES (ROUND)	A MAXIMUM OF 30MM OVERLAP	68 POSTS
2 INCHES (ROUND)	A MAXIMUM OF 20MM OVERLAP	110 POSTS

*\*All sizes tried and tested to specifications mentioned above\**

- Does Not Require any Other Tools To Apply
- Non-Butyl
- Completely UV Stable
- Easy-to-tear
- Quick and Easy Installation

We give the option to acquire a dispenser and a measuring board to have for a demo area for the merchant. The demo board can be requested as a correx board or as a tabletop sticker.

**WALTHER STRONG**

Note: Position the tape on the post approx 50mm above and below ground level

Rail Post  
2" Round

4" Round

4x4 Square

6" Round  
5x5 Square

6x6 Square

7x7 Square

8x8 Square

SCAN ME  
WALTHER STRONG

SCAN ME FOR OUR FULL RANGE

Boards or stickers come in one size only (L) 150cm x (W) 50cm



## FEATURES

- QUICK AND EASY TO APPLY - NO HASSLE
- NO APPLICATION TOOLS OR KITS NEEDED
- GUARANTEED FOR 25 YEARS
- MADE WITH RECYCLED & SUSTAINABLE MATERIALS
- COMPLETELY UV STABLE
- 100MM/150MM AND 200MM WIDTHS
- DESIGNED TO PROTECT SOIL CONTACT POINTS AND MOISTURE SETTLING AREAS

PRODUCT CODE	PRODUCT DESCRIPTION	BOX QTY
SLP200PRO20BLK	200MM X 20MTR BLACK	6
SLP250PRO20BLK	250MM X 20MTR BLACK	6
SLP300PRO20BLK	300MM X 20MTR BLACK	6



SLEEPER TAPE is an environmentally friendly, UV stable, non leaching material that will preserve the lifespan of your sleepers when used for vegetable patches, garden beds or support systems. It will act a timber treatment that will dwarf the capabilities of butyl tape and bitumen paint.

In addition to being made out of recycled materials this product has a guarantee of 25 years. Because of this, the environmental impact is minimal.

Our best performing video in 2023 has done over 6.5M views featuring Sleeper Tape!





# ROOFING



## No Compromise on Quality

In the realm of safeguarding your home, few things are as crucial as ensuring your roof or loft is equipped with top-tier fireproof and watertight products. These elements serve as stalwart defenders against the unpredictable forces of nature and unforeseen accidents, providing an invaluable layer of protection to your property and its inhabitants.

Fireproofing materials act as a formidable barrier against the ravaging spread of flames. In the unfortunate event of a fire outbreak, these materials serve as a crucial deterrent, limiting the blaze's ability to penetrate and engulf your home.

Simultaneously, watertight features fortify your roof against leaks and water ingress. Be it heavy rains, storms, or unexpected plumbing mishaps, these defenses shield your home from moisture damage, mould, and structural deterioration.

The significance of quality fireproof and watertight products in your roof or loft transcends mere functionality; it embodies a proactive approach towards safety and preservation. Investing in these elements isn't just a precaution; it's a commitment to securing your builds.



## FEATURES

- A "CLASS 0" FIRE-RESISTANT & PRESSURE-SENSITIVE ADHESIVE
- QUICK AND EASY TO APPLY WITH 3 SIZES AVAILABLE
- ACTS AS A BARRIER AGAINST MOISTURE, DUST AND MANY CHEMICALS
- STRONG, DURABLE AND LONG LASTING

PRODUCT CODE	PRODUCT DESCRIPTION	BOX QTY
ALU-FOIL/50X45	50MM X 45MTR SILVER	24
ALU-FOIL/75X45	75MM X 45MTR SILVER	16
ALU-FOIL/100X45	100MM X 45MTR SILVER	12

We use a unique adhesive formulation with this product. Not only is it 'class 0' fire resistant, but when peeling the tape from its backing, anti-tear properties prevent annoying snags when pulling long strips from its lining.





## FEATURES

- COMPATIBLE WITH ALL BRANDS OF DAMP PROOF MEMBRANES
- CODE COMPLIANT
- HIGHLY EFFECTIVE DAMP-PROOF SEAL
- COMPLETELY AIR-TIGHT SEAL
- DOUBLE-SIDED
- EXCELLENT ADHESION

PRODUCT CODE	PRODUCT DESCRIPTION	BOX QTY
WS-BT-BLK50X10P	50MM X 10MTR X 1.5MM BLACK	12

Highly effective at creating a continuous damp-proof/airtight seal between two sheets of plastic membrane. Butyl Tape is used when membrane joints cannot be avoided or around protrusions through the membrane.

- Compatible with all damp-proof membranes
- Completely airtight – highly effective damp-proof seal
- Code compliant
- DPM Jointing Tape
- Strong adhesion for overlapping





# RILICONE<sup>®</sup> RANGE

**Our No.1 priority is Reliability!**

Rilicone is 'Reliable Silicone' - why is this important??? With a history of having poorly manufactured silicones in varying mixtures and qualities, you never really know what you're going to get!

We have developed a new reliable premium silicone mixture with the following features:

- Food hygiene approved
- The Best Premium Quality Sealant
- Anti-Fungal
- UV & Aging Resistant
- High Adhesion – Durable, Soft Elastic Outstanding Resilience
- Low Shrinking During Curing

One reliable silicone for all types of applications including:

PVC, Timber, Aluminium, Exterior, Interior, High End Sanitary Situations, Natural Stone, Direct to Glass & Mirror. Saving you time, hassle AND money.



## FEATURES

- RELIABLE SILICONE YOU CAN DEPEND ON FOR ALL PURPOSES
- HIGH QUALITY PRODUCT WITH ZERO ACETATE
- A CRUCIAL PART OF THE RILICONE FAMILY
- COMES IN TRANSPARENT, WHITE AND BROWN

PRODUCT CODE	PRODUCT DESCRIPTION	BOX QTY
RIL-01	TRANSPARENT 310ML TUBE	24
RIL-02	WHITE 310ML TUBE	24
RIL-03	BROWN 310ML TUBE	24



Rilicone has been designed for a really premium finish that lasts a lifetime – getting the job done right the first time. Following this system ensures that each product is used at its best potential & and creates a complete germ-free, water-tight, professional finish that everyone needs in their builds.

Every silicone that claims to be anti-fungal is immediately contaminated when contact is made by anything unsterile (especially hands!). This is why the the RILICONE product range can ensure that your silicone is completely anti-fungal and won't go rotten just a few months down the line like most silicone jobs tend to do – and let's face it, what is worse that mouldy silicone around your nice sanitary ware?

Whole colour range can be found on P54.



# RILICONE<sup>®</sup>

## SMOOTHING SPRAY

36

ONE OF OUR  
BEST SELLERS

### FEATURES

- SOLVENT FREE
- FOR A SMOOTH SURFACE AND CLEAN EDGES
- MAKES A VISUALLY FLAWLESS SEALANT FINISHING BEAD
- PREVENTS MOULD
- SAVES TIME

PRODUCT CODE	PRODUCT DESCRIPTION	BOX QTY
RIL-SMOO	SMOOTHING SPRAY CLEAR 500ML	6



**STEP 1**  
Apply RILICONE in  
an even bead

**STEP 2**  
Spray RILICONE bead  
evenly with smoothing  
spray

**STEP 3**  
Choose RILICONE  
finishing bead and run  
joint spatula down the  
silicone, pressing firmly

RESILIENT  
ROBUST  
RELIABLE

RILICONE  
SMOOTHING SPRAY  
FOR FINISHING BEADS





# RILICONE<sup>®</sup>

## JOINT SPATULAS

37

### FEATURES

- 4 X JOINT SPATULAS MADE OF A FLEXIBLE PLASTIC
- ASSISTING IN CREATING A WATERTIGHT SEAL
- ENSURES NO GERMS ARE PUT INTO THE SILICONE
- CREATES A CLEAN AND CONSISTENT LOOK
- 16 DIFFERENT BEAD FINISHES



RESILIENT  
ROBUST  
RELIABLE

PRODUCT CODE	PRODUCT DESCRIPTION	BOX QTY
RIL-SPAT	4 PIECE (16 EDGE) JOINT SPATULAS	10

Pack of four joint spatulas made of flexible plastic, which are designed for pressing the fresh sealant to the surface to create a germ-free, water-tight seal and also has a clean and uniformly smooth finish.



### COMPLETE THE FAMILY WITH THE FOLLOWING STEPS:

- STEP 1** APPLY SILICONE IN AN EVEN BEADSPRAY SILICONE BEAD
- STEP 2** EVENLY WITH SMOOTHING SPRAY
- STEP 3** CHOOSE YOUR FINISHING BEAD FROM THE 16 DIFFERENT OPTIONS ON YOUR JOINT SPATULA SET
- STEP 4** RUN JOINT SPATULA DOWN THE SILICONE, PRESSING FIRMLY
- STEP 5** ALLOW SILICONE TO FULLY CURE (24 HOURS) BEFORE COMING INTO CONTACT WITH WATER



# ENVELOPE TAPES

## Its the finer details that matter

The ENVELOPE taping range are the products that you need to have at your disposal

In the construction industry, "envelope tapes" typically refer to specialised tapes used in building envelope systems. These tapes play a crucial role in creating a weather-resistant barrier, improving energy efficiency, and preventing air and moisture infiltration in buildings.

These tapes are designed to withstand varying weather conditions, UV exposure, and temperature fluctuations, providing long-term durability and maintaining the integrity of the building envelope. They contribute significantly to the overall performance and longevity of structures by protecting them from water damage, air leakage, and energy loss.

Buildings are long-term investments, and the tapes used in their construction need to withstand environmental factors like temperature changes, UV exposure, and weather conditions for many years. High-quality tapes are engineered to maintain their effectiveness over time, ensuring the building's continued protection and performance.

Tapes used in flashing and house wrap applications help prevent water intrusion. If water seeps into the building envelope due to tape failure, it can cause structural damage, mould growth, and deterioration of building materials, leading to costly repairs.



## FEATURES

- EXTRA THIN AND EXTREMELY STRONG
- COMPATIBLE WITH ISO 9354:1989 / DIN EN 12127 / DIN EN ISO 13934-1 / ISO 4603 / DIN 61101-1 / DIN ISO 9354
- NON-COMBUSTIBLE AND FIRE-RATED
- ANTI-MOULD PROPERTIES

PRODUCT CODE	PRODUCT DESCRIPTION	BOX QTY
WS-FR50X50	50MM X 50MTR FIRE-RATED	36



## CORE BENEFITS OF THE VEIL MESH

- Firewall fibreglass mesh veil for plasterboard joints
- Extremely strong
- DIN. EN12127
- B3/B7 Class
- ISO9354
- Non-Combustible
- Fire-Rated
- 50MMx50M





## FEATURES

- STRONG SELF-ADHESIVE FOR EASY & QUICK APPLICATION
- FAST AND EFFECTIVE ACOUSTIC TAPE
- USED ON ALL WALL & FLOOR SYSTEMS
- SUITABLE FOR TIMBER, STUDS & ZINC JOISTS
- REDUCES NOISE & VIBRATIONS
- TRIALLED & LOVED BY HOME BUILDERS AND LOFT CONVERTERS

PRODUCT CODE	PRODUCT DESCRIPTION	BOX QTY
WS-ACT30X30PR	30MM X 25MTR X 4MM BLACK	30
WS-ACT50X30PR	50MM X 25MTR X 4MM BLACK	18
WS-ACT70X30PR	70MM X 25MTR X 4MM BLACK	12
WS-ACT90X25PR	90MM X 25MTR X 4MM BLACK	10



- Most commonly used for sound proofing on loft conversions
- Easy to apply – self-adhesive backing
- Noise reduction acoustic joint tape
- Dramatically reduces noise & vibrations
- Helping you achieve Building Regulations Part E
- Help reduce flanking noise through structures & party walls
- PERFECT FOR STUDIOS AND REMOVING UNWANTED VIBRATIONS

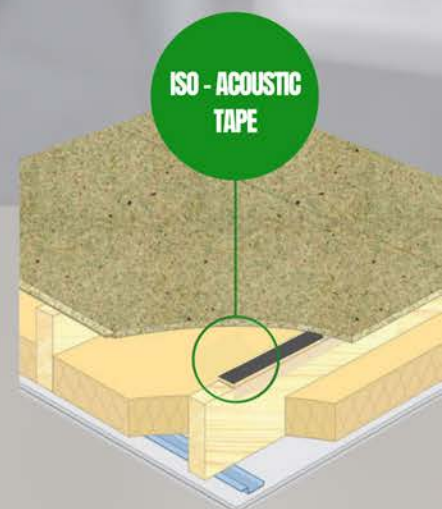



# HD SOUNDPROOFING TAPE

## FEATURES

- FAST AND EFFECTIVE ACOUSTIC RUBBER CRUMB TAPE
- USED ON ALL WALL & FLOOR SYSTEMS
- SUITABLE FOR MARINAS, TIMBER AND ALUMINIUM FRAMEWORK
- DRAMATICALLY REDUCES NOISE & VIBRATIONS
- USED IN LARGE PROJECTS AND CONSTRUCTION SITES
- SUITABLE FOR INTERNAL AND EXTERNAL APPLICATIONS



Soundproofing Marinas all over the Arab nations

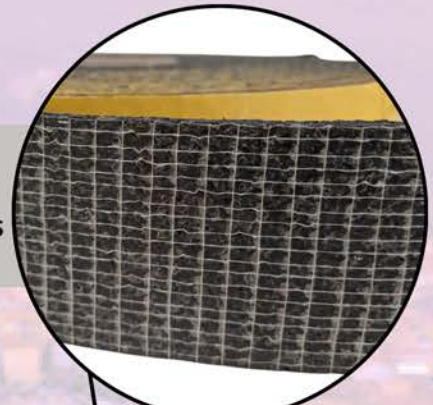

Properties	Information
Colour	Black
Surface	Smooth/Granular
Tensile Strength	0.31N/mm2 (EN ISO 1978)
Elongation at break	42% (EN ISO 1978)
Thickness	5mm Nominal
Carbon Black	1333-86-4
Density	636kg/m3
Service Temp. Range	-30°C to + 82°C



PRODUCT CODE	PRODUCT DESCRIPTION	BOX QTY
WS-ACT-50X10HD	50MM X 10MTR X 4MM BLACK	6



# SELF - EXPANDING FOAM TAPE

42

## FEATURES

- WEATHERPROOF
- PERMANENTLY ELASTIC
- EXCELLENT FOR BOTH SMOOTH & UNEVEN SURFACES
- SELF-ADJUSTS
- SINGLE-SIDED ADHESIVE
- OPEN CELL POLYURETHANE FOAM
- PERFECT FOR COVERING SMALL AIR GAPS FOR WINDOWS AND DOORS

PRODUCT CODE	PRODUCT DESCRIPTION	BOX QTY
WS-SELFEF/33546	25MM WIDE X 4.6MTR	20
WS-SELFEF/33546-10	10MM WIDE X 4.6MTR	48



2 ROLLS WITH 2 DIFFERENT WIDTHS FOR YOUR CONVENIENCE!

BOTH 4.6M LONG  
BOTH HAVE EXPANSIONS BETWEEN 5mm - 35mm

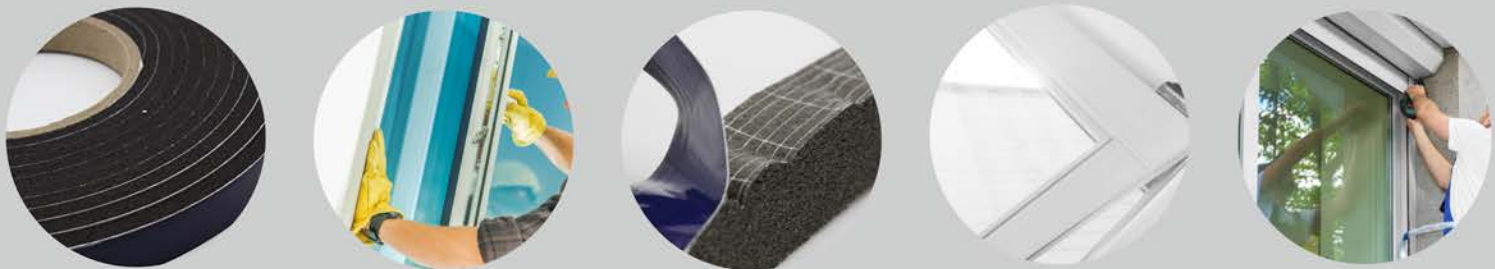



## FEATURES

- THE #1 CHOICE FOR DOUBLE-SIDED TAPE
- LEAVES NO RESIDUE
- DURABLE
- REPOSITIONABLE
- NO SCISSORS REQUIRED - TEARS EASILY BY HAND

PRODUCT CODE	PRODUCT DESCRIPTION	BOX QTY
GALT-25X10/1	10MTR X 25MM DOUBLE-SIDED	72



AS SEEN ON TV

### DOUBLE SIDED INNOVATIVE DESIGN

The adhesive stays sealed in the channels on both sides

This channeled design allows for a completely straight tear by hand. Other benefits include:

- Repositionable
- Double Sided
- School Safe
- Waterproof
- Durable



The unique easy-tear design means you won't need to worry about scissors and it tears straight every time. Perfect for arts and crafts at home or at school, ideal for kids' projects. This double-sided tape can also be repositioned without the sticky residue that is often left by traditional tapes. The durable, waterproof adhesive will be great for making scrapbooks, hanging posters, packaging and a huge number of other uses! Use it to bond wood, plastic, card, metal, glass, leather, china, rubber and carpet.



# MATI MOUNT ULTRABOND TAPE

44

## FEATURES

- BONDS GRP
- USED FOR MOTORWAY SIGNAGE
- EXTERIOR AND INTERIOR USE
- DESIGNED FOR SHEET METAL FABRICATIONS
- WORKS WITH PVC AND STAINLESS STEEL
- DOUBLE-SIDED TAPE
- WOVEN AND REINFORCED
- TENSILE STRENGTH IS EQUAL TO 90 NEWTONS/25MM
- EXTREMELY STRONG, AGGRESSIVE PERMANENT ADHESIVE
- WILL REPLACE MECHANICAL FIXINGS: RIVETS, SCREWS, BOLTS

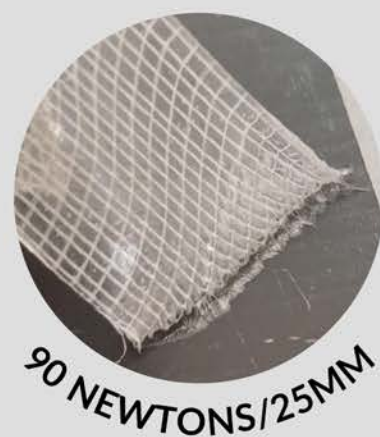

PRODUCT CODE	PRODUCT DESCRIPTION	BOX QTY
WS-MATIMOUNT/25X25	25MM X 25MTR DOUBLE-SIDED	12



Mati Mount is technically part of the MATI range but for now is under the Walther Strong banner - incredible ability to bond heavy duty items together





## FEATURES

- DESIGNED TO CREATE AN AIRTIGHT BARRIER TO STOP UNWANTED AIRFLOW
- SEALS AROUND UNWANTED PENETRATIONS, PIPES, WINDOWS AND MEMBRANE OVERLAPS
- A SINGLE SIDED TAPE - COMES IN BLACK OR WHITE
- TEMPERATURE RESISTANCE FROM  $-40^{\circ}\text{C}$  to  $+100^{\circ}\text{C}$
- DURABLE BONDS FROM HIGH QUALITY ACRYLIC ADHESIVE
- HELPS TO PREVENT INTERIOR MOULD GROWTH

PRODUCT CODE	PRODUCT DESCRIPTION	BOX QTY
HW60X25BLK	HOUSEWRAP TAPE - WHITE - 60MM X 25M	10
HW60X25WHT	HOUSEWRAP TAPE - BLACK - 60MM X 25M	10



## DID YOU KNOW...

Housewrap is crucial in creating an air barrier to stop uncontrolled air flow – helping to prevent interior damage, mold growth, and increased heating and cooling costs. Ultimately, house wrap should boost a home's energy-efficiency and create a healthy, comfortable indoor environment.



# NON-BUTYL AIRTIGHT FLASHING TAPE

# 46

## FEATURES

- INSTANT BOND & GUARANTEED TO LAST 25 YEARS
- SEALS DOORS AND WINDOWS FAST & PERMANENT
- FULLY CURES IN 3-12 HOURS
- COMPLETELY UV RESISTANT & STABLE
- 100% AIRTIGHT AND 100% WATERTIGHT



A REVIEW OF HOUSEWRAP PERFORMANCE AND ITS IMPLIATIONS ON ENERGY SAVINGS

PRODUCT CODE	PRODUCT DESCRIPTION	BOX QTY
ES-100X20P	100MM X 20MTR BLACK	12
ES-150X20P	150MM X 20MTR BLACK	12
ES-200X20P	200MM X 20MTR BLACK	6
ES-250X20P	250MM X 20MTR BLACK	6
ES-300X20P	300MM X 20MTR BLACK	6

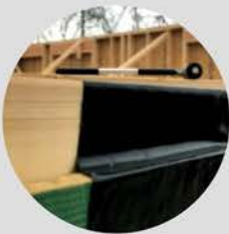

Flashing tape is often referred to as lead flashing tape but is mainly constructed of aluminium foil and bitumen rubber adhesive.

Ours is not... Its a heat-resistant especially designed tape that is non butyl and easy to install!

It is used to provide an immediate watertight seal on a huge range of surfaces making it an essential part of any roofing project. Available in a selection of sizes.



# WALTHER STRONG®

PROVIDING SOLUTIONS TO COMMON  
CONSTRUCTION PROBLEMS

  
beko®

Also the UK wholesaler of  
the Beko brand



**WALTHER  
STRONG**



**beko**



**Roof installation  
Insulation  
Installing Doors/Windows  
Renovating Doors/Windows  
Decking Installation  
Safety**

**Electrical  
Plastering  
Loft Conversions  
Bathroom/ Wetroom installation  
Tiling**





As of November 2020 - Walther Strong has been appointed the exclusive UK wholesaler of all Beko Products to the UK merchant / distributors.

The Beko Group GmbH provides innovative quality products, which have been continuously improved and further developed. Their product line includes sealing compounds, adhesives, aerosols, and application specific accessories.

## PRODUCT CONTENTS



**ALLCON 10**  
**PAGE : 50**



**MS FLEX SEALANT**  
**PAGE : 51**



**B10 UNIVERSAL OIL**  
**PAGE : 52**



**PRO 4 SILICONE**  
**PAGE : 53**

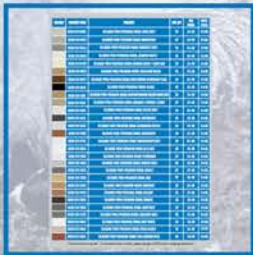

**PRO 4 COLOUR SCHEME**  
**PAGE : 54**



**POS MATERIAL**  
**PAGE : 55**



**ALL CLEAN**  
**PAGE : 56**



**HYDROSTOP**  
**PAGE : 57**



**SPEEDEX**  
**PAGE : 58**



**MEDICAL PLASTERS**  
**PAGE : 59**



**LEAK DETECTION SPRAY**  
**PAGE : 60**



MADE IN  
GERMANY



# ALLCON 10 CONSTRUCTION ADHESIVE



## FEATURES

- FROST-PROOF
- LOW ODOUR
- SHORT TERM RESISTANCE TO TEMPERATURES UP TO +120 C
- SINGLE-COMPONENT
- NO PRIMER NEEDED
- TEST REPORT IN ACCORDANCE WITH DIN EN 204 D4
- HOLDS 130KGS PER SQUARE CENTIMETRE
- SUITABLE FOR INDOOR AND OUTDOOR USE
- FULLY CURES IN JUST 7 TO 10 MINUTES



PRODUCT CODE	PRODUCT DESCRIPTION	BOX QTY
BEKO 260 100 310 EN	310ML	12
BEKO 260 100 150 EN	150ML	20









# MS-FLEX SEALANT & ADHESIVE



## FEATURES

- WEATHER RESISTANT
- EXCELLENT CHEMICAL RESISTANT
- 80% INSTANT GRAB STRENGTH
- NO SOLVENTS OR ISOCYANATES
- PAINTABLE
- DOES NOT SHRINK
- ENVIRONMENTALLY COMPLIANT
- COMPLETELY WATER RESISTANT
- 80% GRAB STRENGTH
- INDOOR & OUTDOOR USE



	PRODUCT CODE	PRODUCT DESCRIPTION	BOX QTY
	BEKO 246 2900 EN	TRANSPARENT 300ML	12
	BEKO 246 290 EN	WHITE 300ML	12
	BEKO 246 290 2 EN	BLACK 300ML	12
	BEKO 246 290 3E N	GREY 300ML	12
	BEKO 246 290 4EN	BEIGE 300ML	12







# B10 UNIVERSAL OIL



## FEATURES

- REMOVES SQUEAKS AND RATTLES
- SUITABLE FOR INDOOR AND OUTDOOR USE
- DOES NOT DRIP OR RUN OFF SURFACE LASTING IN A LONG-TERM FIX
- DISPLACES WATER
- EASY-TO-AIM APPLICATION - ALSO WORKS WHEN THE CAN IS UPSIDE DOWN!



PRODUCT CODE	PRODUCT DESCRIPTION	BOX QTY
BEKO 260 100 310 EN	310ML	12
BEKO 260 100 150 EN	150ML	20







# PRO 4 PREMIUM SILICONE



## FEATURES

- ANTI-FUNGAL FORMULATION
- AVAILABLE IN 36 COLOUR VARIATIONS
- FOOD HYGIENE APPROVED
- ADHERES WITHOUT A PRIMER
- UV & AGEING RESISTANT
- THE BEST CHOICE TO STAND THE TEST OF TIME (IF YOU DON'T WANT TO BE REDOING SILICONE EVERY 2-3 YEARS)



PRODUCT CODE	PRODUCT DESCRIPTION	BOX QTY
(PTO)	(PTO)	20





COLOUR	PRODUCT CODE	PRODUCT	BOX QTY
	BEKO 224 03EN	SILICONE PRO4 PREMIUM 310ML LIGHT GREY	20
	BEKO 224 04EN	SILICONE PRO4 PREMIUM 310ML MANHATTAN	20
	BEKO 224 05EN	SILICONE PRO4 PREMIUM 310ML CONCRETE GREY	20
	BEKO 224 06EN	SILICONE PRO4 PREMIUM 310ML JASMINE MAPLE	20
	BEKO 224 07EN	SILICONE PRO4 PREMIUM 310ML BAHAMA BEIGE / LIGHT OAK	20
	BEKO 224 08EN	SILICONE PRO4 PREMIUM 310ML TAN/LIGHT BEECH	20
	BEKO 224 09EN	SILICONE PRO4 PREMIUM 310ML DARK BROWN MAHOGANY TEAK	20
	BEKO 224 10EN	SILICONE PRO4 PREMIUM 310ML BLACK	20
	BEKO 224 11EN	SILICONE PRO4 PREMIUM 310ML MEDIUM BROWN/BEECH/DARK OAK	20
	BEKO 224 12EN	SILICONE PRO4 PREMIUM 310ML CARAMEL/ SPRUCE/ LARCH	20
	BEKO 224 13EN	SILICONE PRO4 PREMIUM 310ML SILVER GREY	20
	BEKO 224 14EN	SILICONE PRO4 PREMIUM 310ML ANTHRACITE	20
	BEKO 224 15EN	SILICONE PRO4 PREMIUM 310ML ALUMINIUM SILVER	20
	BEKO 224 16EN	SILICONE PRO4 PREMIUM 310ML TERRACOTTA	20
	BEKO 224 17EN	SILICONE PRO4 PREMIUM 310ML TRANSPARENT GREY	20
	BEKO 224 18EN	SILICONE PRO4 PREMIUM 310ML OLD LACE	20
	BEKO 224 19EN	SILICONE PRO4 PREMIUM 310ML PERGAMON	20
	BEKO 224 20EN	SILICONE PRO4 PREMIUM 310ML CEMENT GREY	20
	BEKO 224 21EN	SILICONE PRO4 PREMIUM 310ML BASALT	20
	BEKO 224 22EN	SILICONE PRO4 PREMIUM 310ML OAK	20
	BEKO 224 23EN	SILICONE PRO4 PREMIUM 310ML CHESTNUT	20
	BEKO 224 24EN	SILICONE PRO4 PREMIUM 310ML WALNUT	20
	BEKO 224 25EN	SILICONE PRO4 PREMIUM 310ML BRONZE	20
	BEKO 224 26EN	SILICONE PRO4 PREMIUM 310ML DARK GREY	20
	BEKO 224 27EN	SILICONE PRO4 PREMIUM 310ML SANITARY GREY	20
	BEKO 224 28EN	SILICONE PRO4 PREMIUM 310ML GREY WHITE	20
	BEKO 224 29EN	SILICONE PRO4 PREMIUM 310ML BEIGE/ALDER	20
	BEKO 224 34EN	SILICONE PRO4 PREMIUM 310ML PALE BROWN/TEAK	20

\*Colours are just a guide - for the exact colour match, please request a PRO4 colour range sample chart\*





**PRODUCT CODE : POS/VARIOSHELF**  
SELF-STANDING LARGE DISPLAY UNIT



**PRODUCT CODE : POS/96WIRECDU**  
DISPLAY UNIT - SELF DISPENSING (HOLDS 96 310ML TUBES)



**PRODUCT CODE : POS/PRO4CHART**  
COLOUR RANGE BOARD FOR SILICONE PRO4



**PRODUCT CODE : POS/MSFLEXCDU**  
DEMO COUNTER DISPLAY FOR MS-FLEX



**PRODUCT CODE : POS/ALLCONCDU**  
DEMO COUNTER DISPLAY FOR ALLCON 10



**PRODUCT CODE : POS/ALLCONINFLATE**  
LARGE INFLATABLE ALLCON 10 POS

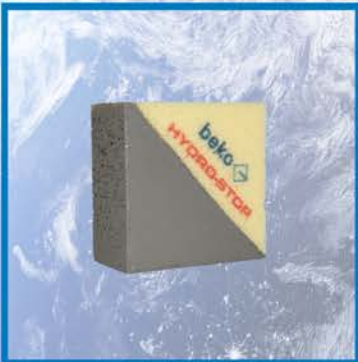

**PRODUCT CODE : POS/HYDROSPONGE**  
DEMO SPONGE FOR HYDROSTOP

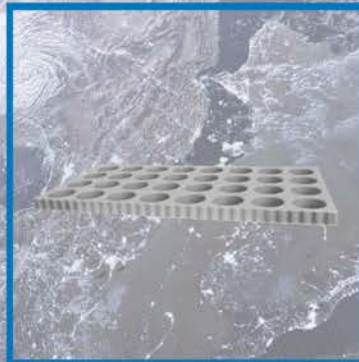

**PRODUCT CODE : POS/32TRAY**  
TRAY FOR 32 AEROSOL 400ML/500ML/750ML



**PRODUCT CODE : POS/55TRAY**  
TRAY HOLDER FOR 55 310ML CARTRIDGES POS

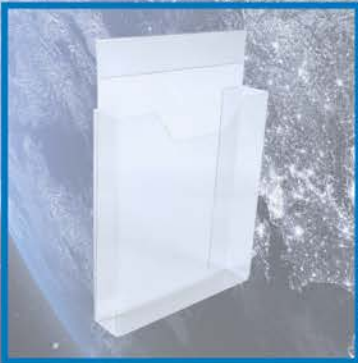

**PRODUCT CODE : LFLTHLDR**  
CLIP ON A5 LEAFLET HOLDERS



**PRODUCT CODE : SHLFTLKR**  
SHELF TALKERS



**PRODUCT CODE : POS-BKOPNCL**  
CARPENTERS LARGE PENCILS FOR GIVEAWAY



# ALLCLEAN



## FEATURES

- DISSOLVES GREASE EASILY
- REMOVES TAR, OIL, PUTTY, GREASE, SILICONE, ADHESIVE, CORROSION PROTECTION AGENTS
- SUITABLE FOR USE ON PLASTIC, METAL, GLASS, PAINTED SURFACES & ACRYLIC [AMONG MANY OTHERS]
- QUICK AND SAFE
- TIME SAVING



PRODUCT CODE	PRODUCT DESCRIPTION	BOX QTY
BEKO 266 120 0500EN	500ML TIN	12





# HYDRO-STOP WATERPROOFING



## FEATURES

- SIMPLE & EFFECTIVE WATER-PROOFING IN BATHROOMS, WET ROOMS
- HIGHLY-FLEXIBLE SO WON'T CRACK IN FUTURE [ESPECIALLY WITH THE REGULAR FLUCTUATIONS IN TEMPERATURE AND HUMIDITY IN THESE ENVIRONMENTS]
- UV, WEATHER AND RESISTANT TO AGEING
- CAN BE USED ON DAMP MINERAL SURFACES
- COMPLIANT TO DIN 18195
- ALSO SUITABLE FOR USE OUTSIDE ON ROOFS AND TO PREVENT LEAKS

PRODUCT CODE	PRODUCT DESCRIPTION	BOX QTY
BEKO 237 2 001EN	1KG RESEALABLE TIN	6
BEKO 237 2 007EN	7KG RESEALABLE TUB	2







# CONSTRUCTION MEDICAL PLASTERS



## FEATURES

- PERMANENTLY ELASTIC
- BREATHABLE MATERIAL
- OIL AND WATER RESISTANT
- LATEX-FREE, THEREFORE ANTI-ALLERGIC
- DOES NOT STICK TO THE WOUND, SO NOT PAINFUL TO REMOVE

PRODUCT CODE	PRODUCT DESCRIPTION	BOX QTY
BEKO 291 8 002 EN	1 KIT - CONTAINS 2 ROLLS	20

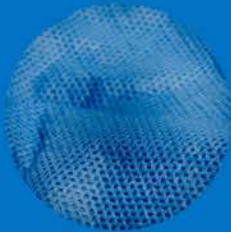



# SPEED-EX



## FEATURES

- COMPLETELY HARMLESS TO SKIN
- EASY APPLICATION
- DOES NOT DRIP OR RUN OFF SURFACE - DISPLACES WATER

PRODUCT CODE	PRODUCT DESCRIPTION	BOX QTY
BEKO 299 60 0750	SPEED-EX PAINT STRIPPER 750ML	6
BEKO 299 60 2500	SPEED-EX PAINT STRIPPER 2.5L	2
BEKO 299 60 5000	SPEED-EX PAINT STRIPPER 5L	2







# LEAK DETECTION SPRAY



## FEATURES

- FOR REGULAR MAINTENANCE INSPECTION LEAK DETECTION
- HARMLESS TO SKIN
- ENVIRONMENTALLY FRIENDLY
- USABLE FROM +5 °C TO +40 °C
- HAS A 360° VALVE

PRODUCT CODE	PRODUCT DESCRIPTION	BOX QTY
BEKO 296 1 400 EN	BEKO LEAK DETECTOR SPRAY 400ML	12





# MATI<sup>®</sup>

## COMPONENT SYSTEMS



Our MATI component systems build bespoke products and solutions for all your construction needs. No request is too big for us - we endeavour to solve your chemical, polymer, adhesive or unique construction problems. Call us to see how we can help you today.

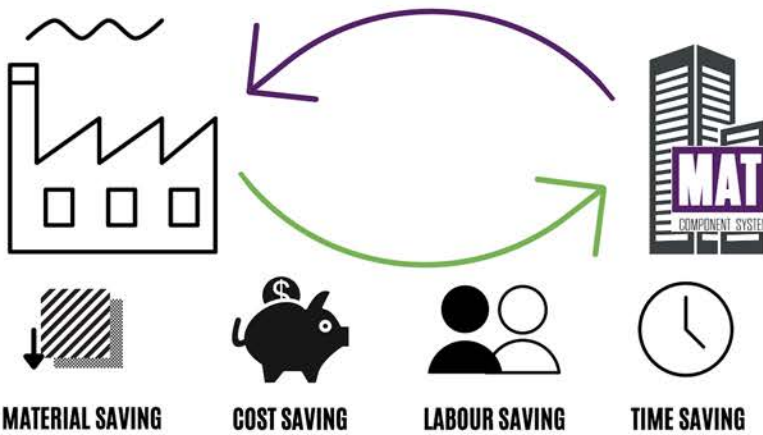

### TECHDATA

#### SQUARE METRE COVERAGE (m<sup>2</sup>):

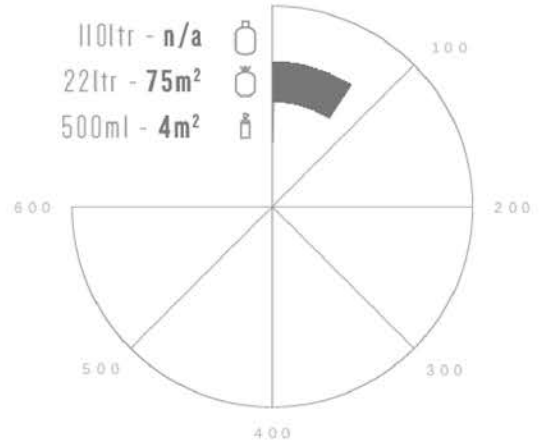

#### APPLICATION:



2 sided

#### FLASH-OFF\*:



1-3 mins

#### OPEN TIME\*:



Up to 40 mins

#### COLOUR:



Orange

#### SUITABLE FOR:



Aluminium Sheeting



Synthetic Leather



Standard Laminate



FRL



Plastic

#### PROPERTIES:



Web Spray



Class-0 Fire Rated

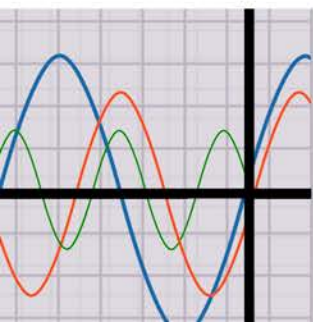



# WALTHER STRONG®

# MATI®

COMPONENT SYSTEMS

# beko®



[waltherstrong.com](http://waltherstrong.com)



01780 437 222